

# Ruijie RG-RAP1200(F) Access Point

## Hardware Installation and Reference Guide



## Copyright

Copyright © 2023 Ruijie Networks

All rights are reserved in this document and this statement.

Without the prior written consent of Ruijie Networks, any organization or individual shall not reproduce, extract, back up, modify, or propagate the content of this document in any manner or in any form, or translate it into other languages or use some or all parts of the document for commercial purposes.



and other Ruijie networks logos are trademarks of Ruijie Networks.

All other trademarks or registered trademarks mentioned in this document are owned by their respective owners.

## Disclaimer

The products, services, or features you purchase are subject to commercial contracts and terms, and some or all of the products, services, or features described in this document may not be available for you to purchase or use. Except for the agreement in the contract, Ruijie Networks makes no explicit or implicit statements or warranties with respect to the content of this document.

The content of this document will be updated from time to time due to product version upgrades or other reasons, Ruijie Networks reserves the right to modify the content of the document without any notice or prompt.

This manual is designed merely as a user guide. Ruijie Networks has tried its best to ensure the accuracy and reliability of the content when compiling this manual, but it does not guarantee that the content of the manual is completely free of errors or omissions, and all the information in this manual does not constitute any explicit or implicit warranties.

# Preface

## Intended Audience

This document is intended for:

- Network engineers
- Technical support and servicing engineers
- Network administrators

## Technical Support

- The official website of Ruijie Reye: <https://www.ruijienetworks.com/products/reeye>
- Technical Support Website: <https://www.ruijienetworks.com/support>
- Case Portal: <https://caseportal.ruijienetworks.com>
- Community: <https://community.ruijienetworks.com>
- Technical Support Email: [service\\_rj@ruijienetworks.com](mailto:service_rj@ruijienetworks.com)

## Conventions

### 1. Signs

This document also uses signs to indicate some important points during the operation. The meanings of these signs are as follows:

---

#### **Caution**

An alert that calls attention to safety instruction that if not understood or followed can result in personal injury.

---

#### **Warning**

An alert that calls attention to important rules and information that if not understood or followed can result in data loss or equipment damage.

---

#### **Note**

An alert that calls attention to essential information that if not understood or followed can result in function failure or performance degradation.

---

#### **Instruction**

An alert that contains additional or supplementary information that if not understood or followed will not lead to serious consequences.

---

#### **Specification**

An alert that contains a description of product or version support.

---

### 2. Note

This manual provides installation steps, troubleshooting, technical specifications, and usage guidelines for cables and connectors. It is intended for users who want to understand the above and have extensive experience in network deployment and management, and assume that users are familiar with related terms and concepts.

# Contents

Preface .....	1
1 Product Overview .....	1
1.1 Technical Specifications .....	1
1.2 Product Image .....	2
1.3 LED Indicator and Button .....	3
2 Preparing for Installation .....	4
2.1 Installation.....	4
2.2 Movement.....	4
2.3 EMI .....	4
2.4 Ventilation .....	5
2.5 Temperature and Humidity.....	5
2.6 Cleanness.....	5
2.7 Installation Tools.....	6
2.8 Unpacking the Access Point.....	6
3 Installing the Access Point .....	7
3.1 Installation Flowchart.....	7
3.2 Before You Begin .....	7
3.3 Precautions.....	7
3.4 Installing the Access Point .....	8
3.5 Connecting Cables .....	9
3.6 Bundling Cables .....	9
3.7 Checking after Installation .....	10
4 Troubleshooting .....	11
4.1 Troubleshooting Flowchart.....	11
4.2 Troubleshooting.....	11
Appendix A Connectors and Media.....	12
Appendix B Cabling Recommendations .....	14

# 1 Product Overview

Featuring leading 802.11a/b/g/n/ac Wave1/Wave2 and MU-MIMO, Ruijie SME RG-RAP1200(F) Wall AP is designed for wireless deployment in hotels, offices, villa and apartment buildings alike. RG-RAP1200(F) supports 2 spatial streams and delivers up to 400Mbps at 2.4GHz and 867Mbps at 5GHz. The overall dual-radio dual-band performance speeds up to 1.267Gbps per device. Providing a 1 10/100Mbps RJ-45 port, RG-RAP1200(F) is deal for both wired and wireless indoor network deployment.

## 1.1 Technical Specifications

Table 1-1 Technical Specifications of RG-RAP1200(F)

Hardware Specifications	
<b>Radio</b>	Dual-radio, dual-band
<b>Transmission Protocol</b>	Concurrent 802.11b/g/n/ac
<b>Operating Bands</b>	802.11b/g/n: 2.4 GHz to 2.4835 GHz 802.11a/n/ac: 5GHz: 5.15 GHz to 5.35 GHz, 5.47 GHz to 5.725 GHz, 5.725 GHz to 5.850 GHz (Country-specific)
<b>Antenna</b>	PCB built-in antenna
<b>Spatial Streams</b>	2.4GHz: 2 streams, 2x2 MIMO 5GHz: 2 streams, 2x2 MIMO
<b>Max Throughput</b>	2.4GHz: up to 400Mbps 5GHz: up to 866.7Mbps Up to 1.2667Gbps per AP
<b>Modulation</b>	OFDM: BPSK@6/9Mbps, QPSK @12/18Mbps, 16-QAM@24Mbps, 64-QAM@48/54Mbps DSSS: DBPSK@1Mbps, DQPSK@2Mbps, and CCK@5.5/11Mbps MIMO-OFDM: BPSK, QPSK, 16QAM , 64QAM and 256QAM
<b>Receive Sensitivity</b>	11b: -97dBm(1Mbps), -92dBm(5Mbps), -89dBm(11Mbps) 11a/g: -94dBm(6Mbps), -85dBm( 24Mbps), -82dBm( 36Mbps), -76.5dBm( 54Mbps) 11n: -93.5dBm@MCS0, -74dBm@MCS7, 74dBm@MCS15 11ac HT20: -92.5dBm( MCS0) , -68.5dBm( MCS8) 11ac HT40: -89dBm( MCS0) , -64dBm( MCS9) 11ac HT80: -86dBm( MCS0) , -60.5dBm( MCS8)
<b>Max Transmit Power</b>	20dBm (adjustable)
<b>Transmit Power Adjustment</b>	1 dBm
<b>Dimensions (W x D x H)</b>	86 mm x 86 mm x 29.3 mm (3.4 in x 3.4 in x 1.2 in)
<b>Weight</b>	Less than 0.14 kg
<b>Service Ports</b>	Front: One 10/100Mbps Ethernet port

	Rear: One 10/100Mbps PoE port
<b>Management Ports</b>	N/A
<b>LED Indicators</b>	Support
<b>Power Supply</b>	PoE 802.3af/802.3at
<b>Power Consumption</b>	≤ 8W
<b>Temperature</b>	Operating: 0°C to 40°C (32°F to 104°F)
	Storage: -40°C to 70°C (-40°F to 158°F)
<b>Humidity</b>	Operating: 5% to 95% RH (non-condensing)
	Storage: 5% to 95% RH (non-condensing)
<b>Installation</b>	Ceiling/wall mount in a 86-type faceplate
<b>IP Rating</b>	IP41
<b>Certification</b>	CE

## 1.2 Product Image

The AP provides one LAN port, one WAN/PoE Port, one reset button and one LED indicator.

Figure 1-1 Image of RG-RAP1200(F)

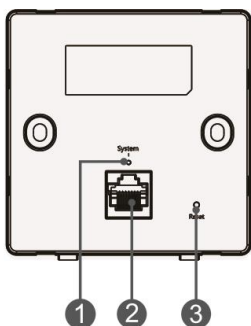

Note: ① System LED Indicator ② LAN Port (RJ45)  
③ Reset Button

Figure 1-2 Bottom View of RG-RAP1200(F)

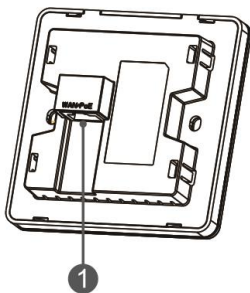



Note: ① WAN/PoE Port

### 1.3 LED Indicator and Button

LED Indicator	State	Frequency	Meaning
Power	Off	N/A	The AP is not receiving power.
	Solid blue	N/A	Normal operation.
	Blinking	0.5Hz	Normal operation, but the AP is not connected to Ruijie Cloud.
	Fast blinking	10Hz	Possible cases: 1. Restoring the factory default settings 2. Upgrading the firmware 3. Restoring the image file 4. Initializing the device
Reset button	Pressed for less than 2 seconds		Restarts the device.
	Pressed for more than 5 seconds		Restores the factory default settings.

## 2 Preparing for Installation

- 
-  To prevent device damage and bodily injury, please read carefully the safety recommendations described in this chapter.
  -  The recommendations do not cover all possible hazardous situations.
- 

### 2.1 Installation

The AP must be installed indoors. To ensure normal operation, the installation site must meet the following requirements.

- Install the AP in a well-ventilated environment. If it is installed in a closed room, make sure there is a good cooling system.
- Make sure the site is sturdy enough to support the AP and its accessories.
- Make sure the site has enough space for installing the AP and leave sufficient room around the AP for ventilation.
- Do not expose the AP to high temperature, dusts, or harmful gases.
- Do not install the AP in an inflammable or explosive environment.
- Keep the AP away from EMI sources such as large radar stations, radio stations, and substations.
- Do not subject the AP to unstable voltage, vibration, and noises.
- Keep the installation site dry. Installing the device near sea is not recommended.
- Keep the AP at least 500 meters away from the seaside and do not face it toward the wind from the sea.
- The installation site should be free from water flooding, seepage, dripping, or condensation.
- The installation site shall be selected according to network planning and features of communications equipment, and considerations such as climate, hydrology, geology, earthquake, electric power, and transportation.

---

 Please follow the correct method described in the installation guide to install and remove the device.

---

### 2.2 Movement

- Avoid moving the device frequently.
- Turn off all power supplies and unplug all power cables before you remove the device.

### 2.3 EMI

- Please observe local regulations and specifications when performing electrical operations. Relevant operators must be qualified.
- Please carefully check for any potential danger in the working area, for example, damp/wet ground or floor.



- Find out the location of the emergency power supply switch in the room before installation. First cut off the power supply in case of an accident.
- Be sure to make a careful check before you shut down the power supply.
- Do not place the device in a damp/wet location. Do not let any liquid enter the chassis
- Keep the AP far away from the grounding or lightning protection devices of power equipment.
- Keep the AP away from radio stations, radar stations, high-frequency high-current devices, and microwave ovens.

 Any nonstandard and inaccurate electrical operation can cause an accident such as fire or electric shock, thus causing severe even fatal damages to human bodies and device.

 Direct or indirect touch through a wet object on high voltage and power line can bring a fatal danger.

## 2.4 Ventilation

For proper ventilation, leave sufficient space around the AP.

## 2.5 Temperature and Humidity

To ensure normal operation and service life of the device, maintain appropriate temperature and humidity levels in your equipment room. See Table 2-1. Improper room temperature and humidity can cause damages to the device.

- High relative humidity may affect insulation materials, resulting in poor insulation and even electrical leakage, and sometimes may lead to change of mechanical properties of materials and corrosion of metal parts.
- Low relative humidity may dry and shrink insulation sheets and cause static electricity that can damage the circuitry inside the device.
- High temperature greatly reduces reliability of the device and shortens its service life.

Table 2-1 Required Temperature and Humidity for the RG-RAP1200

Temperature	Relative Humidity
0°C to 40°C (32°F to 104°F)	5% to 95%

## 2.6 Cleanness

Dust poses a serious threat to device operation. Dust that falls onto the surface of the device can be absorbed onto metal contact points by static electricity, resulting in poor contact. Electrostatic absorption of dust occurs more easily when the relative humidity is low, which may shorten the service life of the device and cause communication failures.

Table 2-2 shows the maximum concentration and diameter of dust allowed in the equipment room.

Table 2-2

Maximum diameter (μm)	0.5	1	3	5
Maximum concentration (Particles/m <sup>3</sup> )	1.4 x 10 <sup>7</sup>	7 x 10 <sup>5</sup>	2.4 x 10 <sup>5</sup>	1.3 x 10 <sup>5</sup>

Besides, the contents of salts, acids and sulfides in the air are also strictly limited for the equipment room. These substances can accelerate metal corrosion and the aging of some parts. Table 2-3 describes the limit of some hazardous gases such as SO<sub>2</sub>, H<sub>2</sub>S, NO<sub>2</sub> and Cl<sub>2</sub> in the equipment room.

Table 2-3

Gas	Average (mg/m <sup>3</sup> )	Maximum (mg/m <sup>3</sup> )
SO <sub>2</sub>	0.2	1.5
H <sub>2</sub> S	0.006	0.03
NO <sub>2</sub>	0.04	0.15
NH <sub>3</sub>	0.05	0.15
Cl <sub>2</sub>	0.01	0.3

## 2.7 Installation Tools

<b>Common Tools</b>	Phillips screwdriver, related copper and fiber cables, bolts, diagonal pliers, cable ties
<b>Special Tools</b>	Wire stripper, crimping pliers, RJ-45 crimping pliers, punch down tool
<b>Meter</b>	Multimeter, bit error rate tester (BERT)

 The listed tools are customer supplied.

## 2.8 Unpacking the Access Point

### Package Contents

<b>Items</b>	Verify that all parts are installed and debugged. Screws Mounting brackets Product quick installation guide Packing list
--------------	--

 The above listed items are for general situations, which may vary in the actual shipment. The purchase order shall prevail in any case. Please check each item carefully according to the packing list or purchase order. If any item is damaged or missing, notify the sales person.

## 3 Installing the Access Point

- 
- i** Make sure you have carefully read Chapter 2, and be sure that the requirements set forth in Chapter 2 have been met.
- 

### 3.1 Installation Flowchart

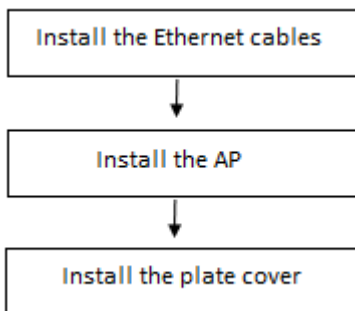

### 3.2 Before You Begin

Before installing the AP, verify that:

- The installation site provides sufficient ventilation for the AP.
- The installation site meets temperature and humidity requirements.
- The installation site is equipped with a proper power supply.
- Network cables are in place.
- The installation site meets all described requirements.
- The custom AP meets customer requirements.

### 3.3 Precautions

To avoid damage to the AP, observe the following safety precautions:

- Do not power on the device during installation.
- Install the device in a well-ventilated location.
- Do not subject the device to high temperatures.
- Keep away from high voltage cables.
- Install the device indoors.
- Do not expose the device in a thunderstorm or strong electric field.

- Keep the device clean and dust-free.
- Disconnect the device before cleaning it.
- Do not wipe the device with a damp cloth.
- Do not wash the device with liquid.
- Do not open the enclosure when the AP is working.
- Fasten the device tightly.

### 3.4 Installing the Access Point

- 1) Loosen screws on the 86-type faceplate that is mounted on the wall.

Figure 3-1 Loosen Screws on the Faceplate

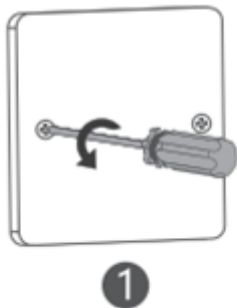

- 2) Connect the Ethernet cable to the WAN/PoE port.

Figure 3-2 Connect the Ethernet Cable to the WAN/PoE Port

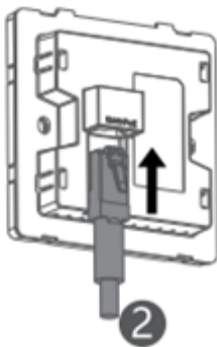

- 3) Align screw holes on both sides of the device over those on the faceplate. And then tighten screws with a screwdriver.

Figure 3-3 Tighten Screws with a Screwdriver

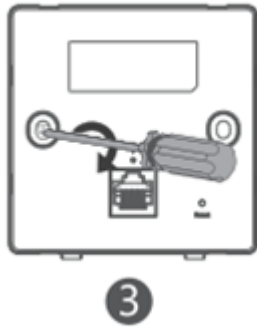

- 4) Install the plate cover in the way as shown in Figure 3-4.

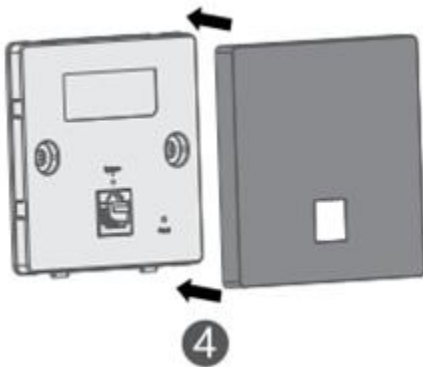

Figure 3-4 Install the Plate Cover



After installation, verify that the LED indicator is working properly.

## 3.5 Connecting Cables

Connect the UTP/STP to the WAN/PoE port on the AP. See Appendix A for the supported wiring for twisted pairs.

-  Avoid bending the cable in a small radius close to the connector.
-  Ruijie recommends that you do not use Ethernet cables with protective sleeves as they could make installation of Ethernet cables more difficult.

## 3.6 Bundling Cables

### Precautions

- Make sure the cable bundles are neat and orderly.
- Bend twisted pairs naturally or in a large radius close to the connector.
- Do not over tighten a cable bundle as it may reduce cable life and performance.

## Bundling Steps

1. Bundle the drop UTP/STP cables and route them to the WAN/PoE port.

Attach the cables in the cable tray of the rack.

Extend the cables under the AP and run in a straight line.

## 3.7 Checking after Installation

### Checking the Cabinet

- Make sure the external power supply matches the patch panel specifications for the cabinet.
- After installation, make sure that the front and rear cabinet doors easily close.
- Make sure the cabinet is stable and level.
- Make sure the device and all cables are securely fastened in the rack.

### Checking Cable Connection

- Make sure the UTP/STP cable matches the interface type.
- Make sure cables are properly bundled.

### Checking the Power Supply

- Make sure all power cables are properly connected and safe.
- Make sure the AP is operational after powering on.

## 4 Troubleshooting

### 4.1 Troubleshooting Flowchart

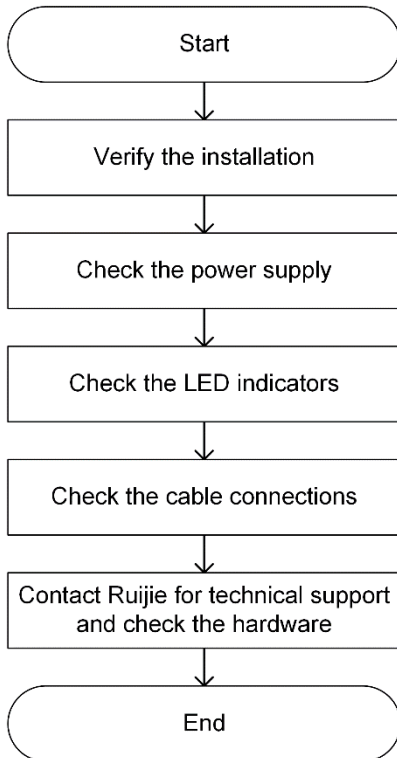

### 4.2 Troubleshooting

#### **LED does not light up after the AP is powered on**

Verify that the power source is IEEE 802.11af compliant. And then verify that the cable is connected properly.

#### **Orange LED blinks after the Ethernet cable is connected**

Verify that the device at the other end of the Ethernet cable is working properly. And then verify that the Ethernet cable is capable of providing the required data rate and is properly connected.

#### **Wireless client cannot find the AP**

- 1) Follow the above-mentioned two steps.
- 2) Verify that the AP is configured correctly.
- 3) Adjust the transmit power.
- 4) Move the client device to adjust the distance between the client and the AP.

## Appendix A Connectors and Media

### 1000BASE-T/100BASE-TX/10BASE-T

The 1000BASE-T/100BASE-TX/10BASE-T is a 10/100/1000 Mbps auto-negotiation port that supports auto MDI/MDIX.

Compliant with IEEE 802.3ab, 1000BASE-T requires Category 5e 100-ohm UTP or STP (STP is recommended) with a maximum distance of 100 meters (328 feet).

1000BASE-T requires all four pairs of wires be connected for data transmission, as shown in Figure A-1.

Figure A-1 1000BASE-T Connection

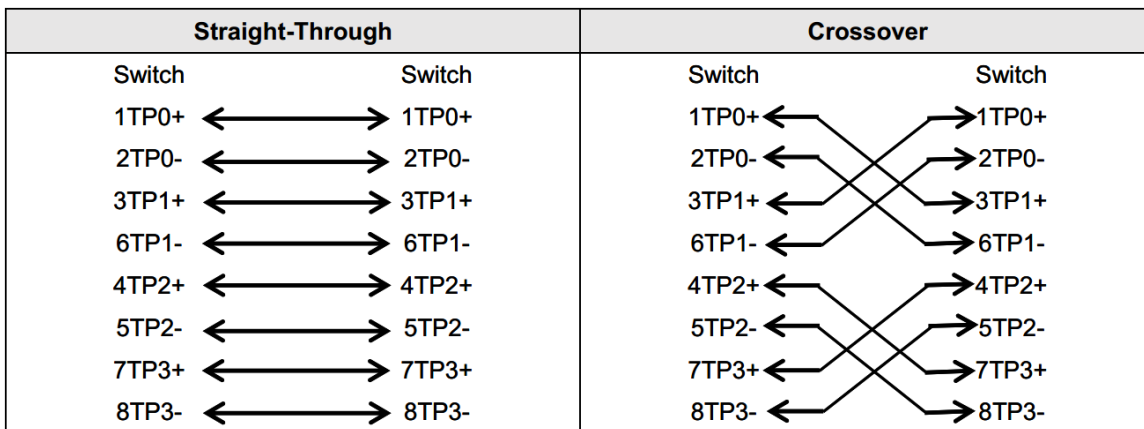

10BASE-T uses Category 3, 4, 5 100-ohm UTP/STP and 1000BASE-T uses Category 5 100-ohm UTP/STP for connections. Both support a maximum length of 100 meters. Table A-1 shows 100BASE-TX/10BASE-T pin assignments.

Table A-1 100BASE-TX/10BASE-T Pin Assignments

Pin	Socket	Plug
1	Input Receive Data+	Output Transmit Data+
2	Input Receive Data-	Output Transmit Data-
3	Output Transmit Data+	Input Receive Data+
6	Output Transmit Data-	Input Receive Data-
4, 5, 7, 8	Not Used	Not Used

Figure A-2 shows wiring of straight-through and crossover cables for 100BASE-TX/10BASE-T.

Figure A-2 100BASE-TX/10BASE-T Connection



Straight-Through		Crossover	
Switch	Adapter	Switch	Switch
1 IRD+	1 OTD+	1 IRD+	1 IRD+
2 IRD-	2 OTD-	2 IRD-	2 IRD-
3 OTD+	3 IRD+	3 OTD+	3 OTD+
6 OTD-	6 IRD-	6 OTD-	6 OTD-

## Appendix B Cabling Recommendations

During installation, route cable bundles upward or downward along the sides of the rack depending on the actual situation in the equipment room. All cable connectors should be placed at the bottom of the cabinet rather than be exposed outside of the cabinet. Power cords should be routed upward or downward beside the cabinet close to the location of the DC power distribution cabinet, AC power outlet, or lightning protection box.

### Required Minimum Cable Bend Radius

- The minimum bend radius of a power, communication or flat cable should be 5 times the overall diameter of the cable. If the cable is constantly bent, plugged or unplugged, the bend radius should be 7 times the overall diameter.
- The minimum bend radius of a coaxial cable should be 7 times the overall diameter of the cable. If the cable is constantly bent, plugged or unplugged, the bend radius should be 10 times the overall diameter.
- The minimum bend radius of a high-speed cable, such as an SFP+ cable should be 5 times the overall diameter of the cable. If the cable is constantly bent, plugged or unplugged, the bend radius should be 10 times the overall diameter.

### Precautions for Cable Bundling

- Before bundling cables, correctly mark labels and stick the labels to cables where appropriate.
- Cables should be neatly and properly bundled, as shown in Figure B-1.

Figure B-1 Bundling Cables

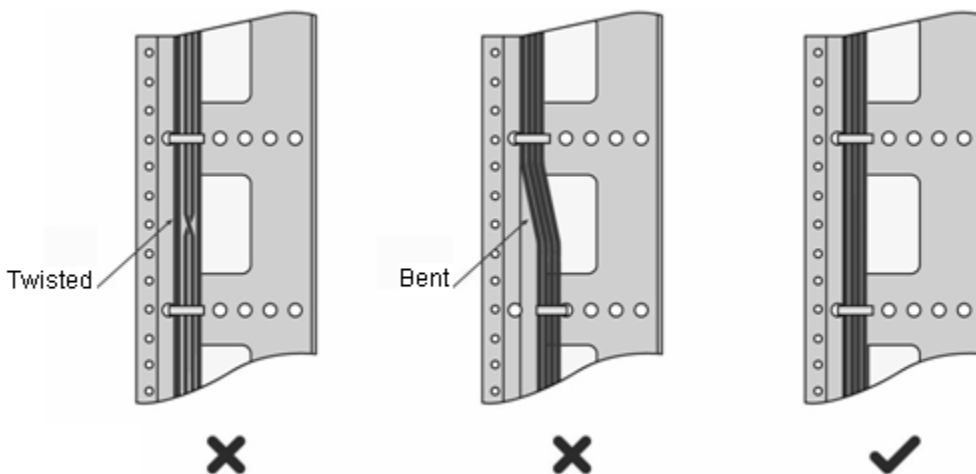

- Route and bundle power, signal, ground cables separately. When the cables are close to each other, cross them. When power cables run parallel to signal cables, the distance between them must be greater than 30 mm.
- All cable trays and their accessories shall be smooth and free from sharp edges.
- Holes in metal, through which cables pass shall have smooth, well-rounded surfaces or be protected with insulating bushings.
- Use proper cable ties to bind cables together. Do not tie two or more cable ties to bind cables.
- Cut off excess cable tie cleanly with no sharp edges after bundling cables, as shown in Figure B-2.

Figure B-2 Cutting off Excess Cable Tie

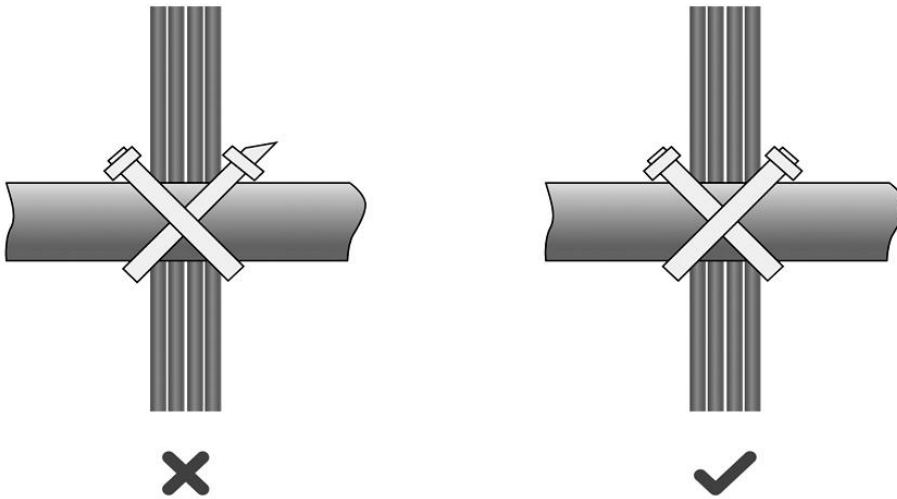

- If cables are to be bent, bind them first but do not tie cable ties within the bend to avoid stress on the cables, which may otherwise cause the wires inside to break, as shown in Figure B-3.

Figure B-3 Do Not Tie Cable Ties within the Bend

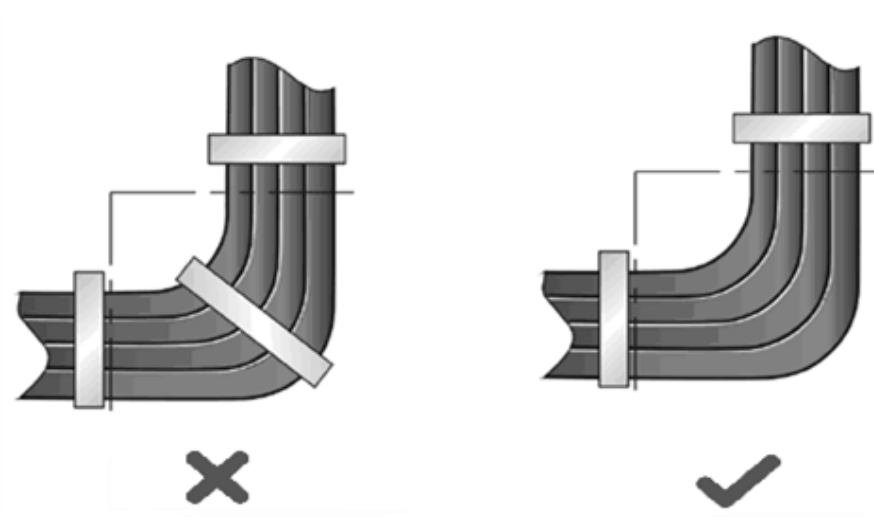

- Wrap up unnecessary or excess cables and bind them to the appropriate rack position, where device operation is not affected and no damages occur to the device and cables during debugging.
- Do not bind power cords to the rails for moving parts.
- Leave a certain length of the cable connecting moving parts, such as the ground wire of the cabinet door, to avoid stress on the cable; When moving parts are in place, ensure the excess cable length shall not contact heat sources, sharp corners or edges. If heat sources are unavoidable, use high-temperature cables instead.
- When using screws to fasten cable lugs, the bolts or nuts shall be tightened and prevented from loosening, as shown in Figure B-4.

Figure B-4 Fastening Cable Lugs

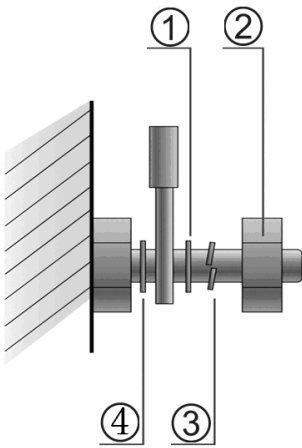

**Note**

1. Flat washer	3. Spring washer
2. Nut	4. Flat washer

- When using a stiff cable, fix it near the cable lug to avoid stress on the lug and cable.
- Do not use self-tapping screws to fasten terminals.
- Bundle cables of the same type and running in the same direction into groups. Keep cables clean and straight.
- Cables shall be tied according to the following table.

Diameter of Cable Bundle (mm)	Space between Bundles (mm)
10	80 to 150
10 to 30	150 to 200
30	200 to 300

- Do not tie knots for cables or cable bundles.
- The metal parts of the cold-pressed terminal blocks, such as air circuit breakers, shall not be exposed outside of the blocks.